



ICAO

UNITING AVIATION

NO COUNTRY LEFT BEHIND



ICAO provisions on data link implementation

Crystal Kim

- *Technical Officer, Airspace Management and Optimization Section*
- *Secretary of Operational Data Link Working Group (OPDLWG) and Air Traffic Management Requirements and Performance Panel (ATMRPP)*

**Operational Data Link Seminar
Bangkok, Thailand, 2 – 4 May 2016**



- **GANP and ASBUs**
- **ATS Data Link Today**
- **ICAO SARPs, PANS and Manuals**
- **Amendments to Annexes and PANs applicable in Nov 2016**



ICAO

UNITING AVIATION

NO COUNTRY LEFT BEHIND



GANP and ASBUs



GANP – A Global Roadmap





GANP – A Global Roadmap

- The Global Air Navigation Plan
- The Roadmaps

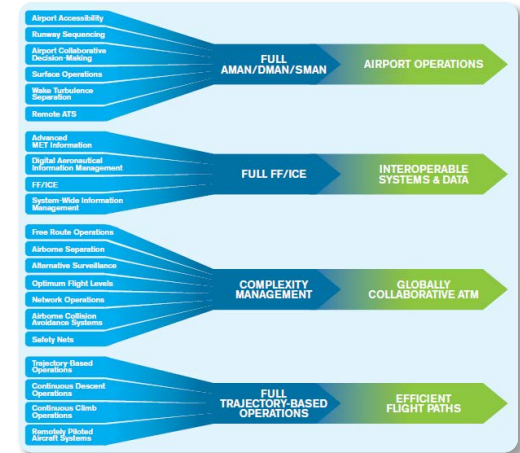
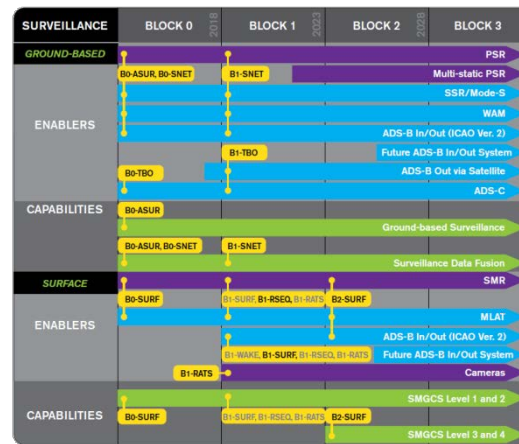



GANP – A Global Roadmap

- The Global Air Navigation Plan
- The Roadmaps
- The Content

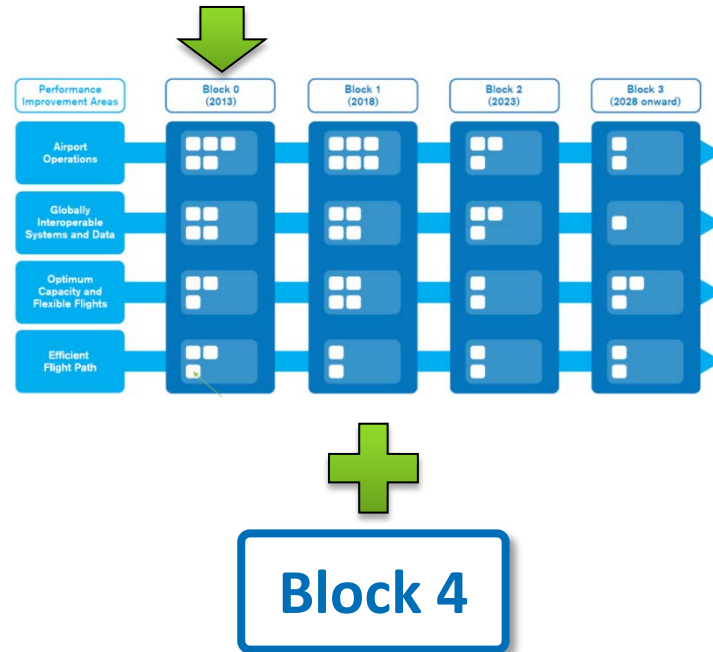



GANP – A Global Roadmap

- **Provides certainty :**
 - In equipage
 - For industry
 - For investment
 - In research and development direction





ICAO's 10 Key Air Navigation Policy Principles

06 Regional and State Air Navigation Priorities

- ICAO regions, sub-regions and individual States through the PIRGs should **establish their own Air Navigation priorities** to meet their individual needs and circumstances in line with the Global Air Navigation Priorities



ICAO's 10 Key Air Navigation Policy Principles

08 Use of ASBU Blocks and Modules

- Although the GANP has a global perspective, it is not intended that all ASBU modules are to be applied around the globe.
- When the ASBU blocks and modules **are adopted by regions**, sub-regions or States they should be followed **in close accordance with the specific ASBU requirements** to ensure **global interoperability and harmonization** of air traffic management
- It is expected that **some ASBU modules will be essential** at the global level and therefore may eventually be the subject of **ICAO mandated implementation dates**.



Relevant Modules in ASBU

Performance Improvement Area 4: Efficient Flight Paths – Through Trajectory-based Operations

Block 0	Block 1	Block 2	Block 3
<p>B0-TBO Improved Safety and Efficiency through the initial application of Data Link En-Route Implementation of an initial set of data link applications for surveillance and communications in ATC.</p>	<p>B1-TBO Improved Traffic Synchronization and Initial Trajectory-Based Operation Improve the synchronization of traffic flows at en-route merging points and to optimize the approach sequence through the use of 4DTRAD capability and airport applications, e.g. D-TAXI, via the air-ground exchange of aircraft derived data related to a single controlled time of arrival (CTA).</p>		<p>B3-TBO Full 4D Trajectory-based Operations Trajectory-based operations deploys an accurate four-dimensional trajectory that is shared among all of the aviation system users at the cores of the system. This provides consistent and up-to-date information system-wide which is integrated into decision support tools facilitating global ATM decision-making.</p>



Dependencies of TBO modules

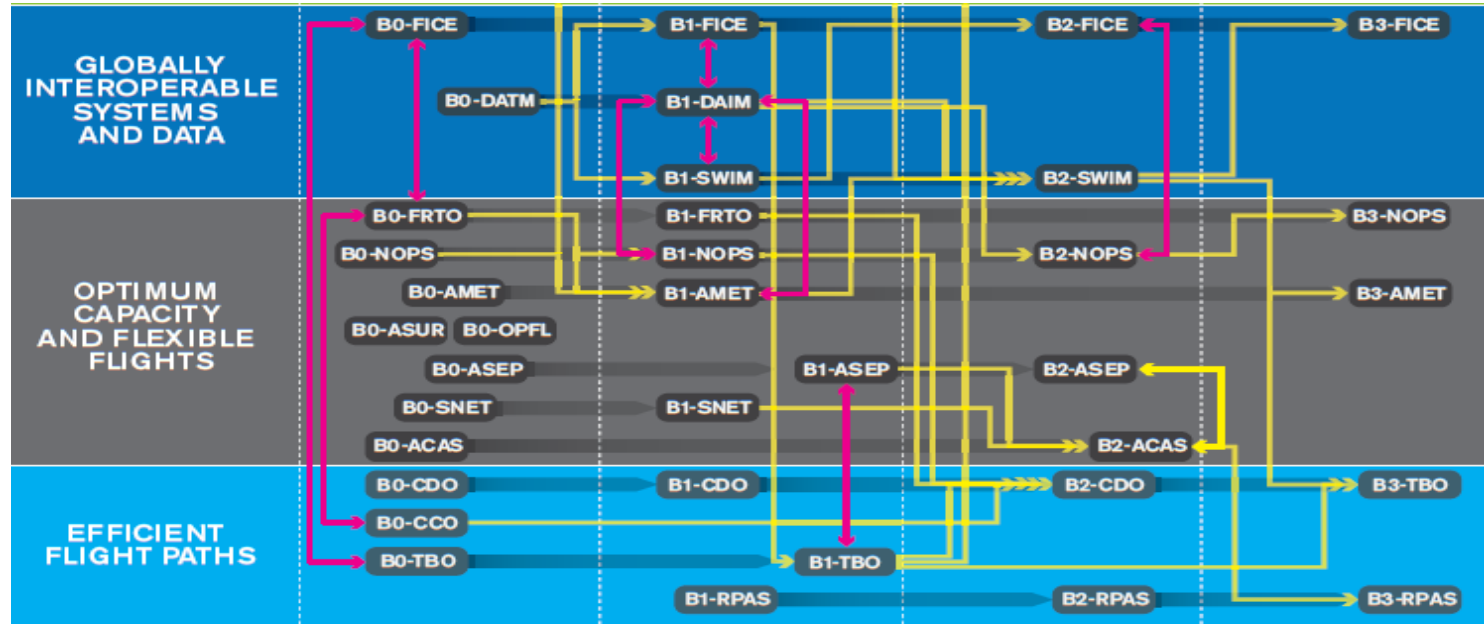



ICAO

UNITING AVIATION

NO COUNTRY LEFT BEHIND



ATS Data Link Today

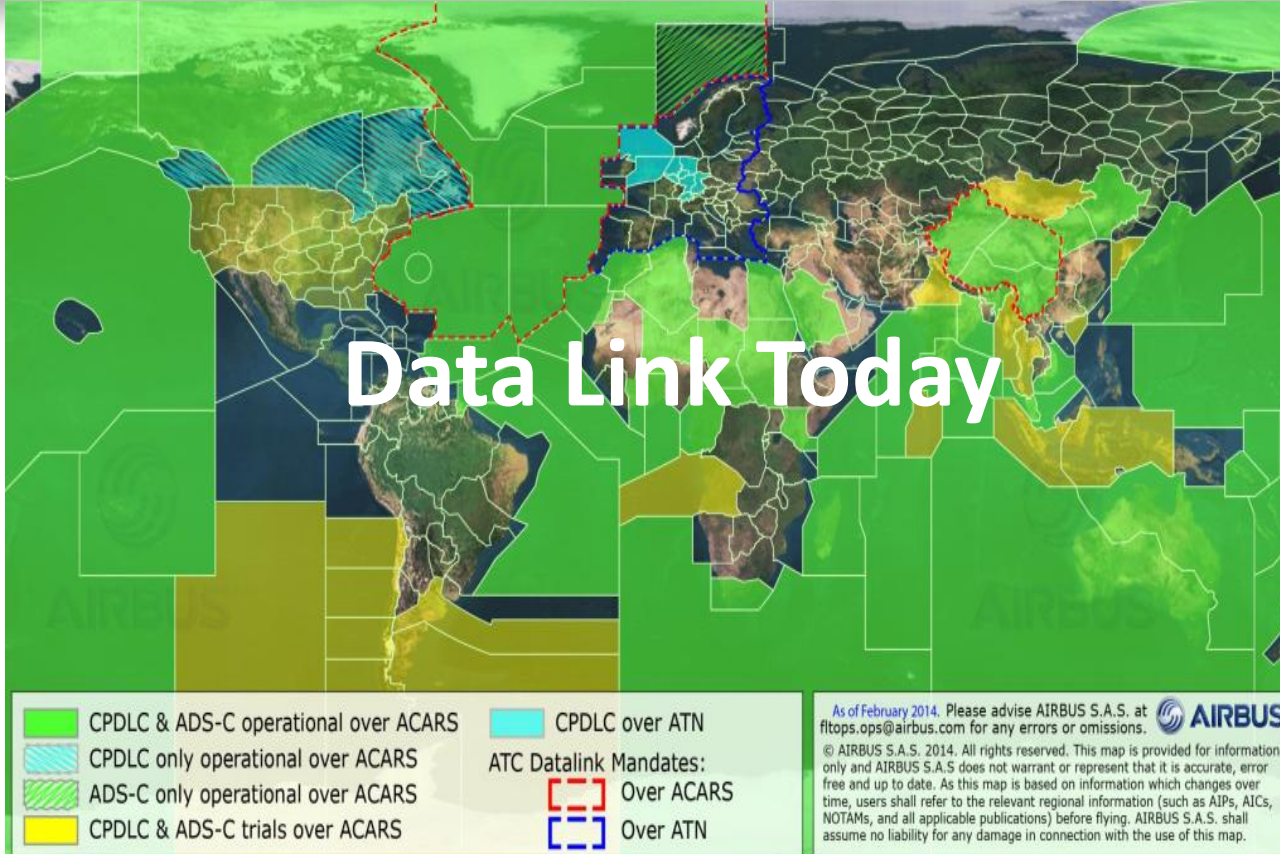

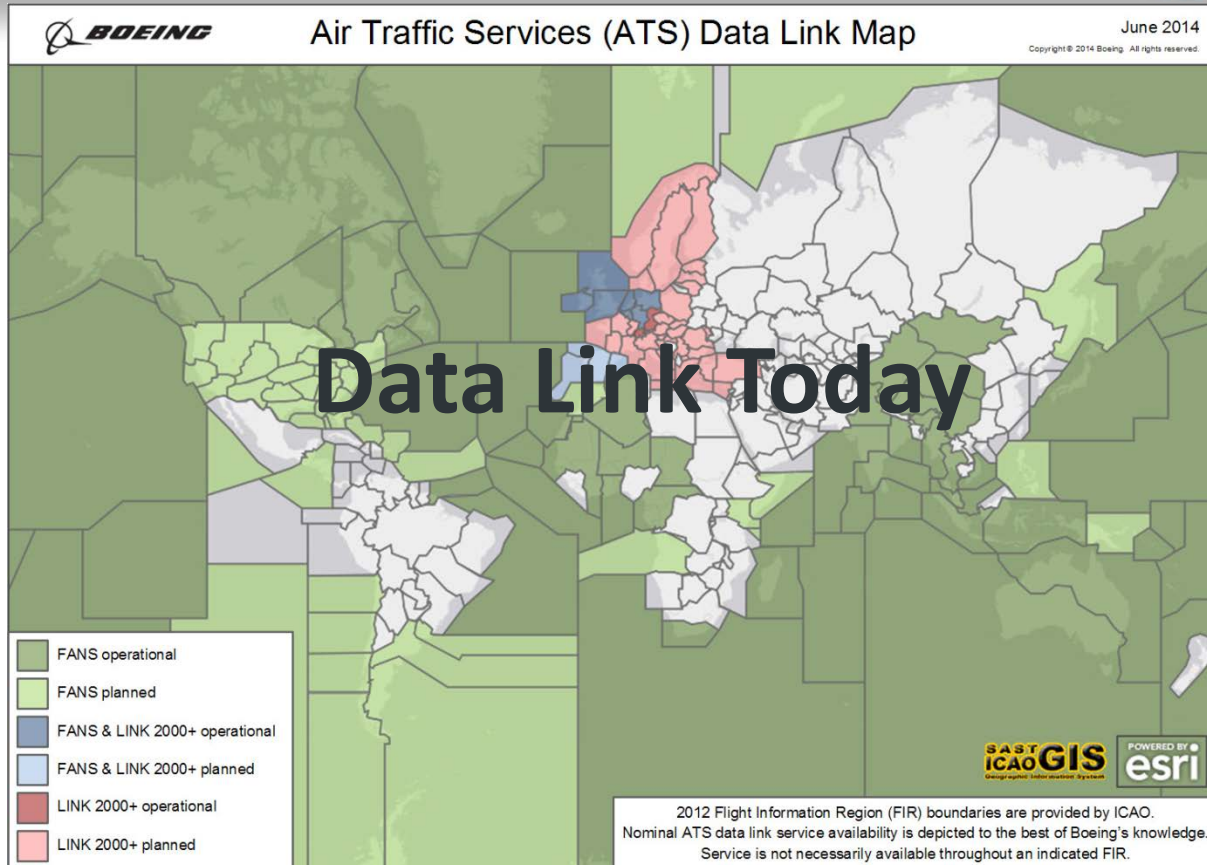



Trip Time: 16:32 / Block Time: 17:15 / Trip Fuel: 217652 / GND DIST: 8020NM / GC DIST: 7683NM



B777-200LR DXB-AKL/02MAR16

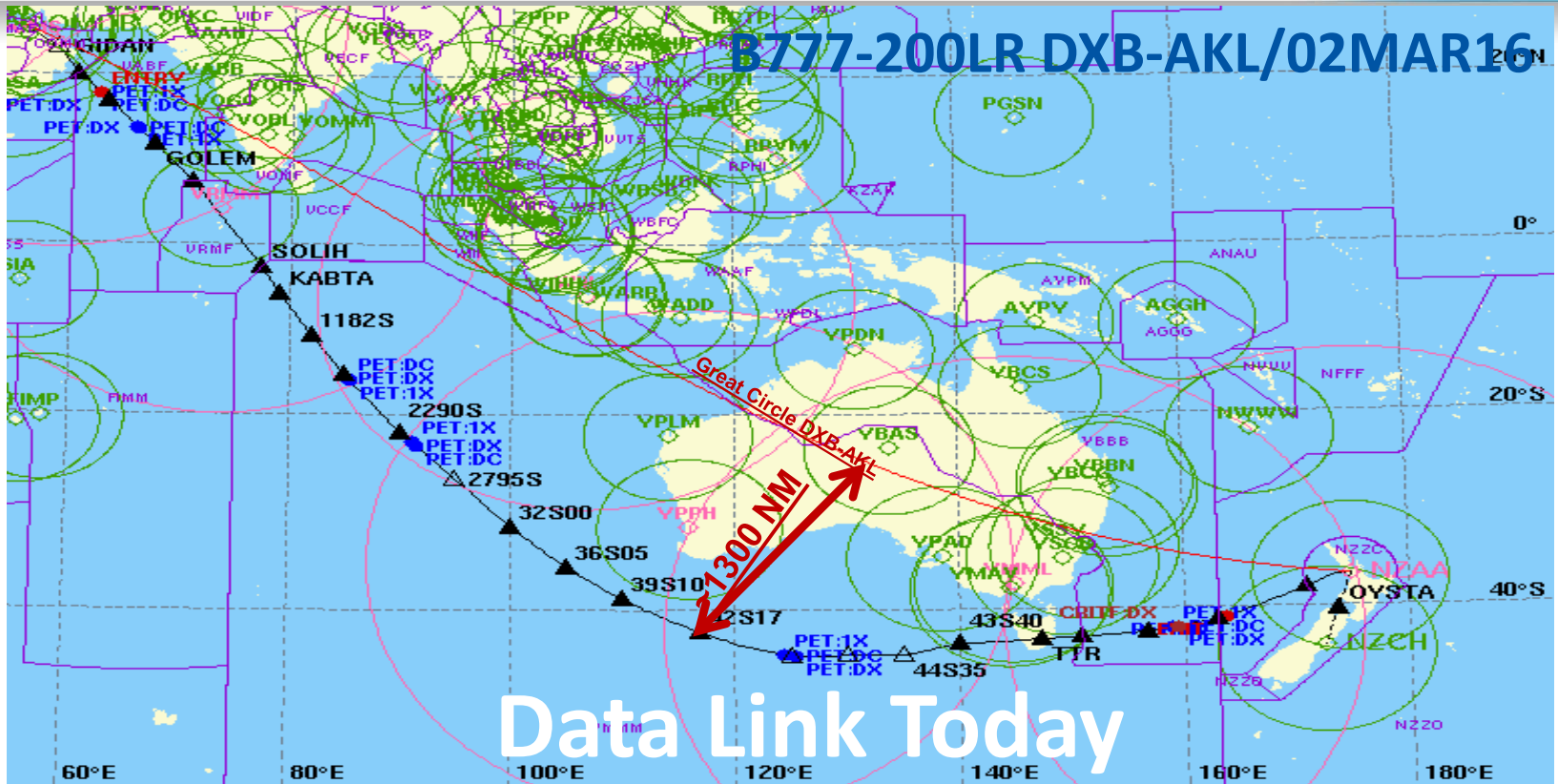

Data Link Today



Why Data Link ?

- **Enhanced conformance monitoring capability** in the airspace over remote and oceanic areas
- clear messages with **less risk of misunderstandings**
- additional, independent and secure channel, which **reduces the strain on busy sector frequencies**
- **Increased capacity and the day-to-day efficiency** of communications between controllers and pilots



Why Data Link ?

- Air traffic is predicted to **double** in the next 15 years
- Our collective responsibility is to **allow the aviation system** to safely realize this growth
- **Use of data link may not be optional** anymore to increase efficiency and optimize the use of available airspace





Why Data Link ?

- When you apply **separation standards that rely on data link capability and performance**
 - 30 NM and 50 NM longitudinal separation,
 - RLatSM – 23 NM lateral separation,
 - RLongSM – 5 Minutes longitudinal separation
- If you **lose the data link connection, you may have lost separation**



- ✓ *Is data link connection always satisfactory ?*
- ✓ *Do all data link systems have same performance ?*
- ✓ *Are all personnel involved well-trained ?*

The answer is.....????



Annexes, PANS and Manuals

Related to Data Link Implementation



Two Aspects to Data Link

- **The “Service and Message”**
 - *“Content” and “Procedures”*
 - *Handled by OPLINKP (Now OPDLWG)*

- **The “Medium”**
 - *Various media and the network supporting them*
 - *Handled by ACP (Now DCIWG)*



OPDLWG and DCIWG???

- In 2014, the Communications Panel (CP) was formed by the merging of the OPLINKP and ACP.
- The CP has two “specific” Working Groups
 - ***Operational Data Link Working Group***
 - Former OPLINKP, dealing with Operational Issues
 - ***Data Communications Infrastructure Working Group***
 - Former ACP, dealing with Technical Issues



For Services and Messages

- **Annex 10 Volume II is the key “standard”**
 - Composition of data link messages
 - Display of data link messages
 - CPDLC procedures
- **Supported by PANS-ATM and Manuals**

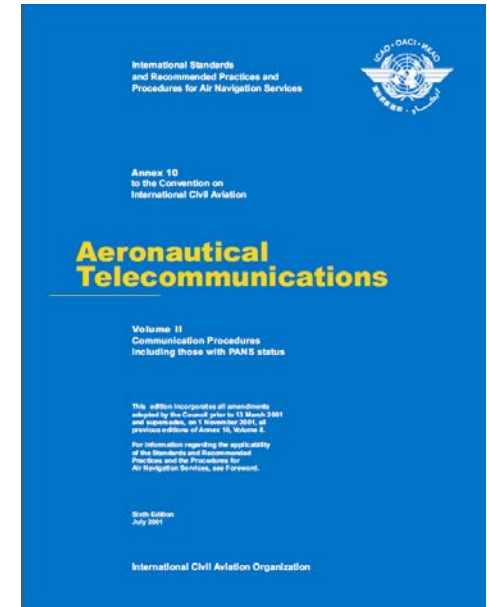



PANS-ATM (Doc 4444)

Chapter 4 General Provisions for Air Traffic Services

- 4.11 Position Reporting
 - 4.11.4 Transmission of ADS-C reports
 - 4.11.5 Contents of ADS-C reports
- 4.15 Data Link Communications initiation Procedures

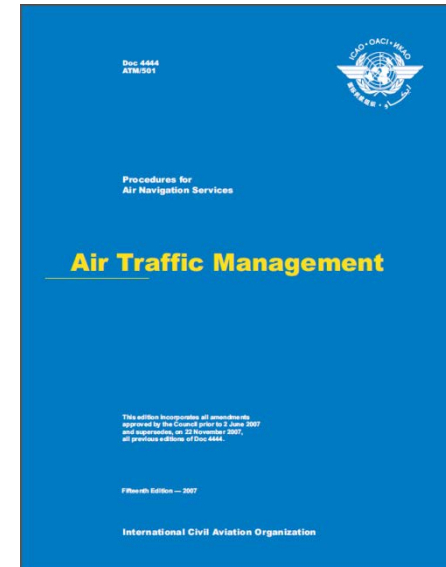



PANS-ATM (Doc 4444)

Chapter 5 Separation methods and minima

Chapter 13 ADS-C Services

- ADS-C Ground system capabilities
- ADS-C related aeronautical information
- Use of ADS-C in the provision of ATC service
- Use of ADS-C in the application of separation minima

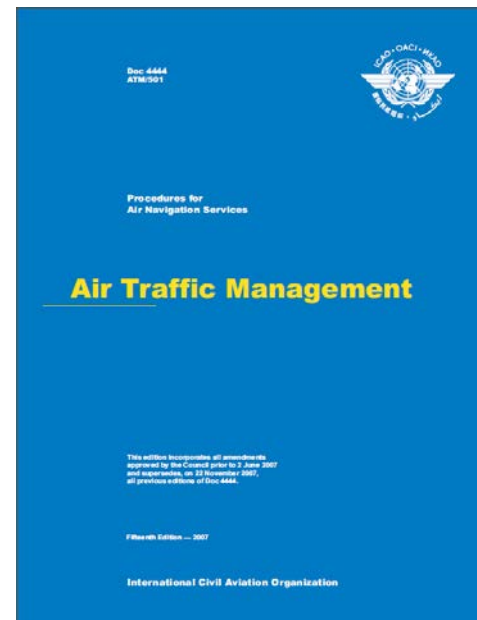



PANS-ATM (Doc 4444)

Chapter 14 CPDLC

- Establishment of CPDLC
- Exchange of operational CPDLC messages

Appendix 2 Flight Plan, Item 10

Appendix 5 CPDLC Message Set

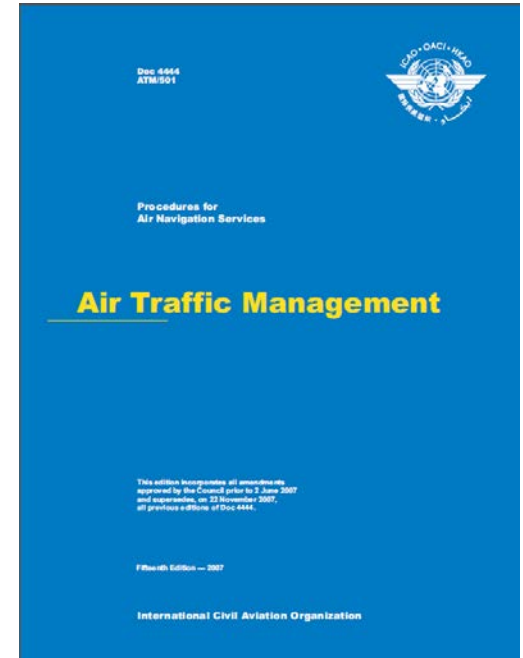



Global Operational Data Link (GOLD) Manual (Doc 10037, Edition 1)



- Supersedes regional GOLD V.2 dated 26 April 2013
- RCP/RSP specifications and post-implementation monitoring removed from regional GOLD and moved to PBCS Manual
- Additional changes made to ensure that No conflicts with provisions in Annex and PANS including and up to 2016 amendment
- To be published in July/August 2016



Global Operational Data Link Manual (Doc 10037, Edition 1)

Chapter 1. Overview of data link operations

Chapter 2. Administrative provisions related to data link operations

Chapter 3. Controller and radio operator procedures

Chapter 4. Flight crew procedures

Chapter 5. Advanced ATS supported by data link

Chapter 6. State aircraft data link operations

Appendix A CPDLC message elements and standardized free text message elements

Appendix B Regional/State specific information

Appendix C Operator/aircraft specific information



For the Media...

- Annex 10 Volume III is the key “standards” document.
- Supported by a number of ICAO Manuals

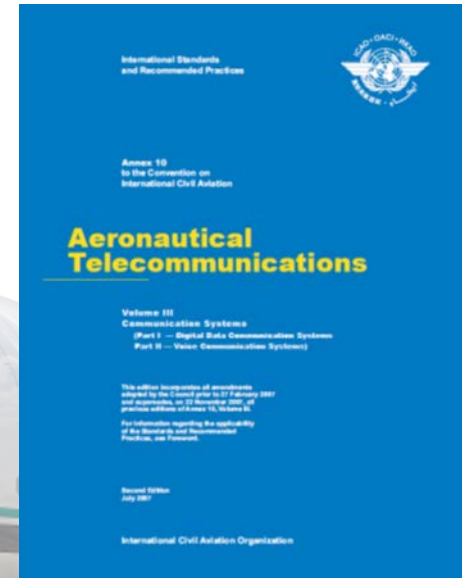



ICAO Manuals on Data Link Media ⁽¹⁾

- **For the ATN**, there are two key documents
 - **Doc 9880**: *Manual on Detailed Technical Specifications for the Aeronautical Telecommunication Network (ATN) using ISO/OSI Standards and Protocols*
 - **Doc 9896**: *on the Aeronautical Telecommunication Network (ATN) using Internet Protocol Suite (IPS) Standards and Protocols*



Doc 9880

- **Air-Ground Applications**
 - CPDLC, CM, ADS-C (tbd), FIS (tbd)
- **Ground-Ground Applications**
 - AMHS, AFTN/AMHS Gateway
- **Upper-Layer Communications Services; Internet Communications Services**
- **Directory Services, Security and Identifier Registration**
- **2nd Edition to be published in late 2016.**

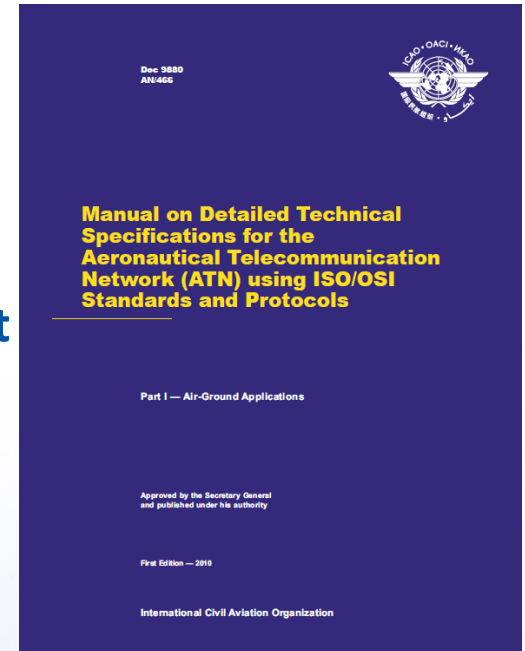



Doc 9896

- **Detailed Tech Specs**
 - Network, Transport and Security
- **IPS Applications**
 - VOIP
 - Including convergence functions for legacy (OSI) applications
- **Guidance Material**

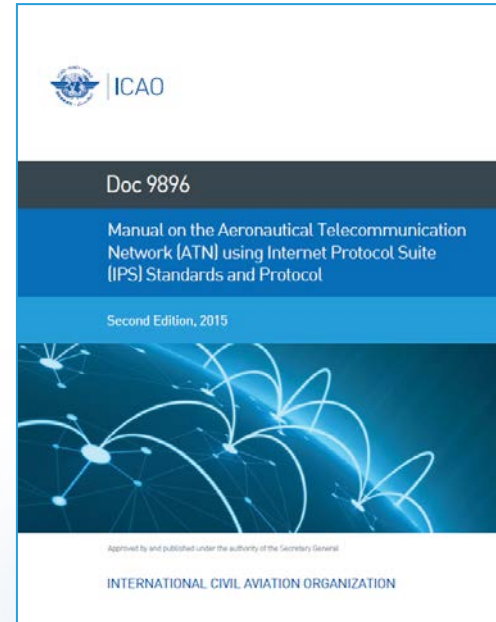



ICAO Manuals on Data Link Media ⁽²⁾

- **For individual media:**
 - **Doc 9776:** *Manual on VHF Digital Link (VDL) Mode 2*
 - **Doc 9925:** *Manual on Aeronautical Mobile (Route) Service*
 - **Doc 10044:** *Manual on Aeronautical Mobile Airport Communications System (AeroMACS) (to be published in 2016)*



Doc 9776

- **2nd Edition in 2015**
 - Has multi-frequency support for NextGen/SESAR
 - Solves congestion-based problems to date.
- **Is OSI-based and is part of LINK2000.**

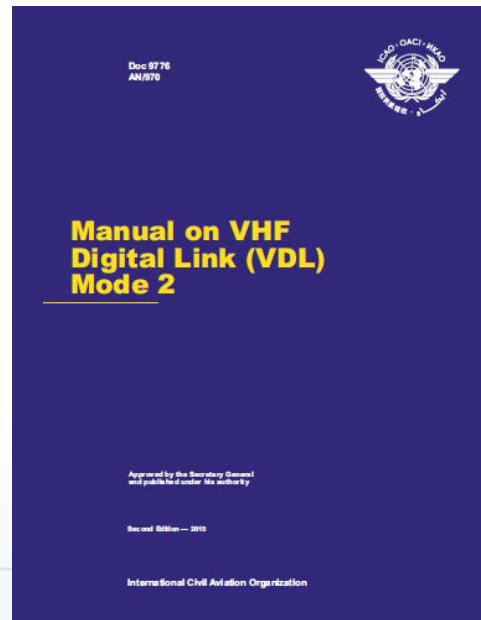



Doc 9925

- **First Edition**

- INMARSAT Classic, ACARS-based plus supports OSI but never used.
- Iridium, ACARS-based

- **2nd Edition - late 2016**

- SwiftBroadband (SBB)
- Supports ACARS and IPS

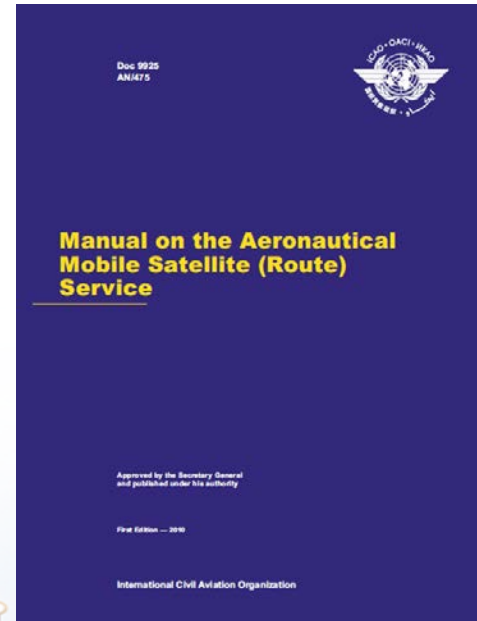



Doc 1044 (AeroMACS)

- **First Edition due late 2016**
 - A10 SARPS become applicable at that time.
- **Supports IPS**
 - Manual will have provisions on Security
 - Also guidance on operation before ATN/IPS becomes operational



Amendments to Annexes and PANS Applicable in Nov. 2016



Amendment Concerning

- Data Link Initiation Capability
- ADS-C and CPDLC
- **Performance-based Communication and Surveillance**
- **Performance-based separation minima**
- Satellite Voice Communication



Applicable in November 2016

- **Affected Documents**

- Annexes 4, 6 (Parts I, II, III), 10 (Vol II, III), 11 and 15; PANS-ATM; PANS-ABC

- **Improvements:**

- Harmonized data link and SATVOICE procedures allowing for seamless operations
- Enhanced communication capabilities for flight operations in remote and oceanic areas

- **Expected Benefits:**

- Reduction in data link connectivity errors between aircraft and ATS facilities and/or reduction in data link communications error
- Safer application of reduced separation in the oceanic airspace for aircraft equipped with CPDLC and ADS-C.
- Transition towards the implementation of a converged data link solution in the future without impacting technical interoperability of current implementation



PBCS Framework

- *Prescription of RCP and RSP* for air traffic services that are predicated on communication and surveillance performance (**Annex 11**);
- *Approval of aircraft and operators* for a communication and/or surveillance capability including aircraft equipage for operations where RCP and/or RSP specifications have been prescribed (**Annex 6**);
- *indication of an aircraft's communication and surveillance capability and performance* in the form of RCP/RSP specifications in the flight plan (**PANS-ATM**);
- *monitoring programmes to assess actual communication and surveillance performance* against RCP and RSP specifications (**Annexes 6 and 11**);
- *corrective actions*, as applicable, for the appropriate entity (**Annexes 6 and 11**).

PBN

RVSM



Performance-based Communication and Surveillance Manual (Doc 9869)

- Developed based on the RCP Manual (Doc 9869), GOLD, SVGM and other regional material
- Expanded the scope to include:
 - PBCS concept and surveillance capability
 - RCP and RSP specifications;
 - information and guidance provided from several workshops held in the regions; and
 - material from PIRG meetings and their contributory groups
- To be published in July/August 2016

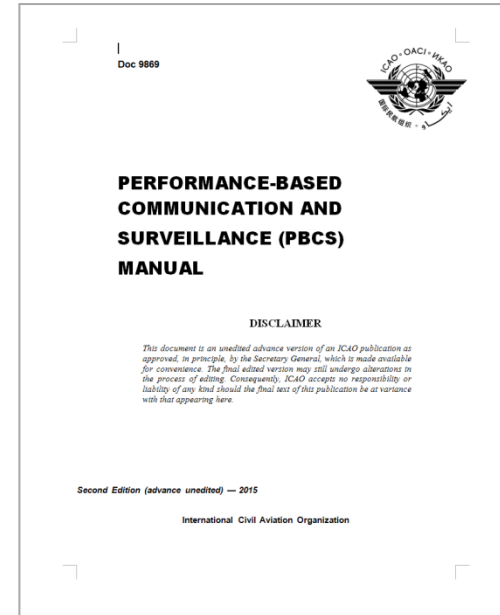



Performance-based Communication and Surveillance Manual (Doc 9869)

Chapter 1. Definitions

Chapter 2. PBCS concept

Chapter 3. Developing RCP/RSP specification

Chapter 4. Applying RCP/RSP specification

Chapter 5. Complying with RCP/RSP specification

Appendix A. PBCS implementation plan- checklist

Appendix B. RCP specifications

Appendix C. RSP specifications

Appendix D. Post-implementation monitoring and corrective action (CPDLC and ADS-C)

Appendix E. Post-implementation monitoring and corrective action (SATVOICE)

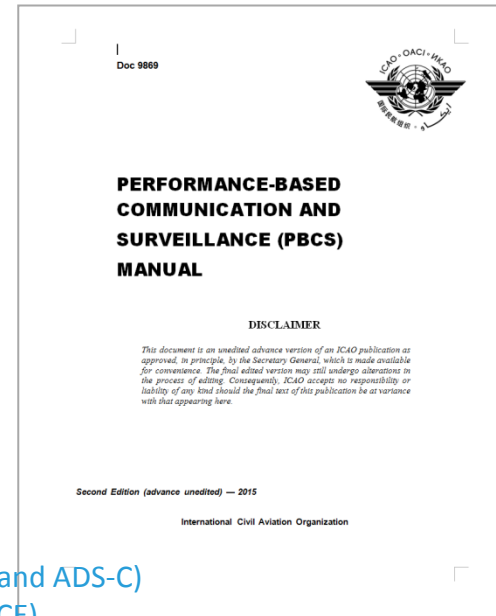



Performance-based Separation



RADAR
DCPC VHF



OCEANIC /
PROCEDURAL

Filling in the Gaps between Radar and Procedural Separations

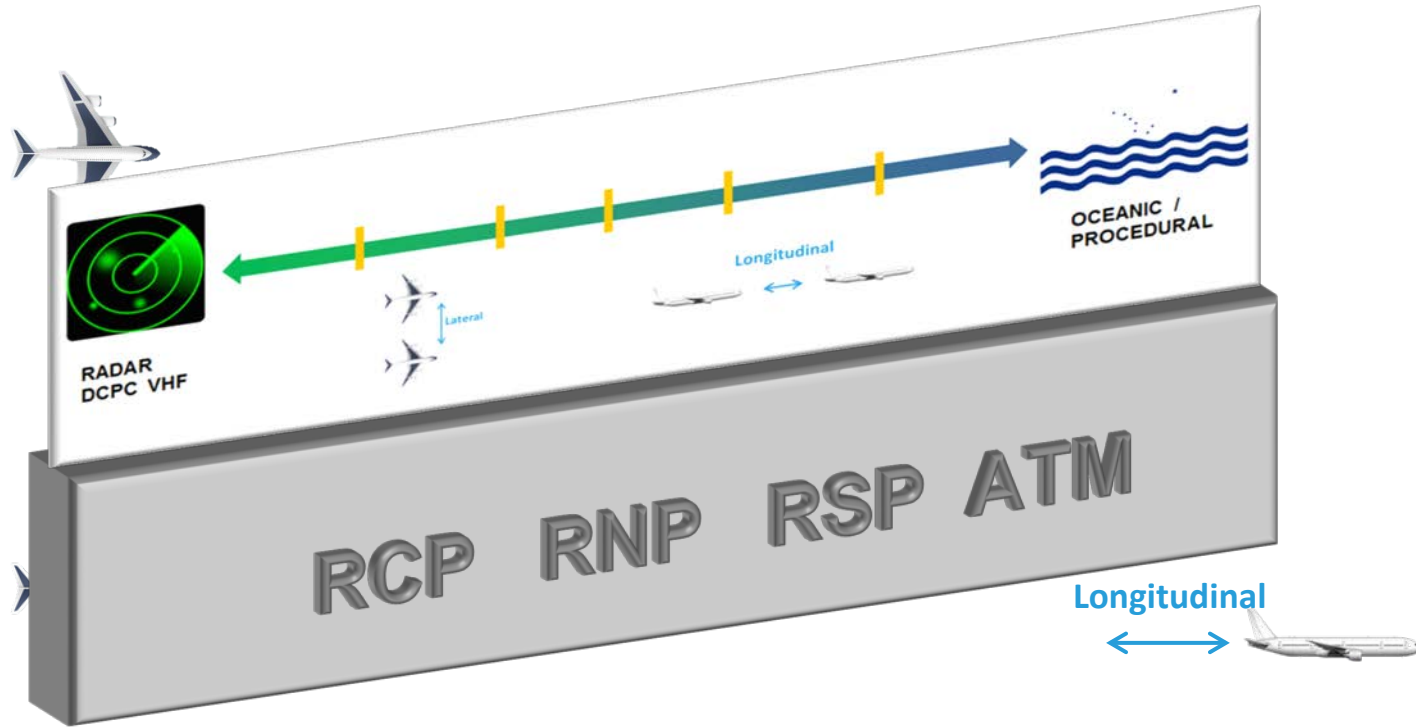



Lateral Separation



Not less than 30
NM (55.5 Km)



- **NAVIGATION** : *RNP 4 or RNP 2*
- **COMMUNICATION** : *RCP 240*
- **SURVEILLANCE** : *RCP 180*
- lateral deviation change event with a maximum of 5 NM threshold and a waypoint change event



Longitudinal Separation



Not less than 10 Minutes



- **NAVIGATION** : *RNP 10, RNP 4 or RNP 2*
- **COMMUNICATION** : *RCP 240*
- **SURVEILLANCE** : *RSP 180*
- Cruising, climbing or descending on the same or crossing track



Longitudinal Separation



Not less than 10 Minutes



- **NAVIGATION** : *RNP 10, RNP 4 or RNP 2*
- **COMMUNICATION** : *RCP 240*
- **SURVEILLANCE** : *RSP 180*
- Cruising, climbing or descending on the same or crossing track



Summary & Conclusions

- ATS Data Link is a fundamental enabler for realizing the concept of future operations (FF-ICE, TBO and SWIM)
- However, further work is needed to ensure seamless and safe implementation of ATS Data Link
- There are a number of ICAO Annexes, PANS and Manual concerning ATS Data Link (Service/Message and Media) and they are evolving.
- There is an increasing need of application of performance-based ATM operations predicated on data link capabilities and performance



Questions?





ICAO

UNITING AVIATION

NO COUNTRY LEFT BEHIND



ICAO

North American
Central American
and Caribbean
(NACC) Office
Mexico City

South American
(SAM) Office
Lima

ICAO
Headquarters
Montréal

Western and
Central African
(WACAF) Office
Dakar

European and
North Atlantic
(EUR/NAT) Office
Paris

Middle East
(MID) Office
Cairo

Eastern and
Southern African
(ESAF) Office
Nairobi

Asia and Pacific
(APAC) Sub-office
Beijing

Asia and Pacific
(APAC) Office
Bangkok



THANK YOU